

QUATTRO 5KW/24V/240V-60Hz AC INVERTER/CHARGER

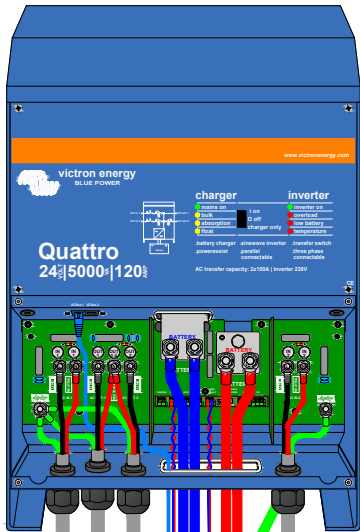

AUTOTRANSFORMER 32A SPLIT PHASE SETUP 240VAC TO 120/240VAC

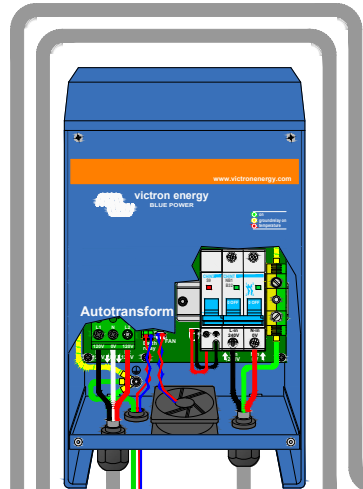

240VAC FROM GENERATOR

240VAC FROM Shore Power

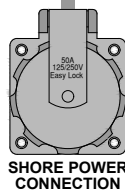

SHORE POWER CONNECTION

MAIN INCOMING AC BREAKERS TOWARDS QUATTRO

Drawing BJE-261A

IMPORTANT INFORMATION !

When connecting a Multi or a Quattro inverter charger to 240V/60 Hz the proper connecting code is as follows: Line becomes L1 (Black wire) and Neutral becomes L2 (Red wire). The Neutral itself (White) will not be connected inside the inverter charger. The Ground wire will be Green. In case of 120V/60Hz Line becomes L (Black wire) and Neutral becomes N (White wire). The Ground wire will be Green.

BLOCK DIAGRAM QUATTRO WITH AUTOTRANSFORMER

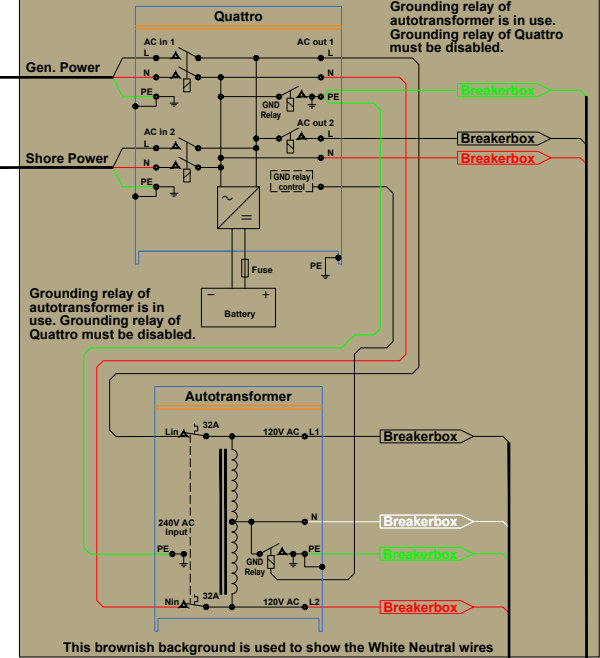

IMPORTANT INFORMATION !

The maximum current for a 32A Autotransformer is 32A through L1 and L2. In case of a 120V load imbalance between L1 and L2, the maximum Neutral current is 32A max for 30 minutes and 28A continuously.

IMPORTANT INFORMATION !

GFIC's (ground fault circuit interrupter) and/or ELCI's (equipment leakage circuit interrupter) are not visible in this drawing, this depends heavily on the end user and the design of its system. The MCB's inside the breaker boxes in this drawing need to be seen as examples only.

Grounding relay of autotransformer is in use. Grounding relay of Quattro must be disabled.

- VE Bus remote control connection-B
- Battery temp sense connection-E
- Battery minus connection-F
- Battery minus connection-F
- Battery positive connection-G
- Battery positive connection-G
- Primary ground connection-L

IMPORTANT INFORMATION !

When operating in inverter mode, the Neutral output of a inverter/charger must be connected to ground to guarantee proper functioning of a GFCI or RCD device. In case of a split phase supply the Neutral also must be grounded. For this purpose a grounding relay is built inside the autotransformer enclosure. The relay is controlled by the Multi or Quattro.

The grounding relay inside the Multi or Quattro must be disabled ! This also depends on the configuration setup between the Autotransformer and the inverter/charger. More info in the manual.

The primary Case ground connections from a inverter charger like a Multi or a Quattro, must be connected to the Central Negative Busbar of the DC system. The primary Case ground connection of the Autotransformer also needs to be connected to the Central Negative Busbar of the DC system.

Grounding relay of autotransformer is in use. Grounding relay of Quattro must be disabled.

Primary ground connection

Quattro AC IN-2

Autotrans. GND Relay

Quattro AC IN-1

Quattro AC OUT-1

Quattro AC OUT-2

QUATTRO AC OUT-2 240VAC ONLY

QUATTRO AC OUT-1 THROUGH AUTOTRANSFORMER WITH SPLIT PHASE SUPPLY 2 X 120VAC AND 1 X 240VAC

120V/240VAC outputs

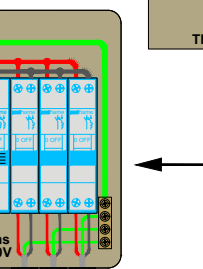
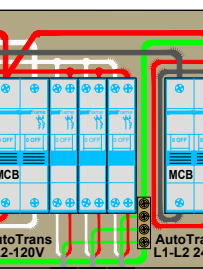
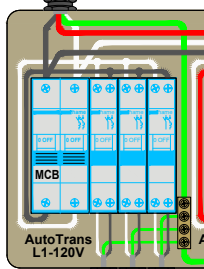
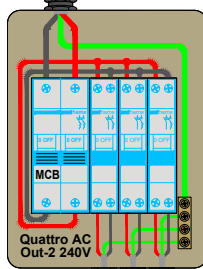

Breakerbox

Breakerbox

Breakerbox

Breakerbox

- < 240V Switched load-1
- < 240V Switched load-2
- < 240V Switched load-3
- < 120V L1 No Break load-1
- < 120V L1 No Break load-2
- < 120V L1 No Break load-3
- < 120V L2 No Break load-1
- < 120V L2 No Break load-2
- < 120V L2 No Break load-3
- < 240V L1-L2 No Break load-1
- < 240V L1-L2 No Break load-2
- < 240V L1-L2 No Break load-3